

B-B (1 : 2)

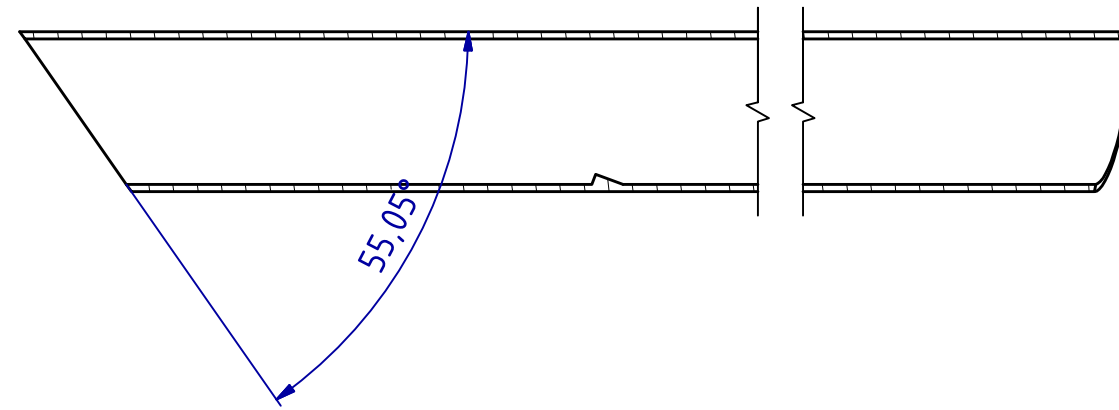

A-A (1 : 2)

