

M 1:2,5

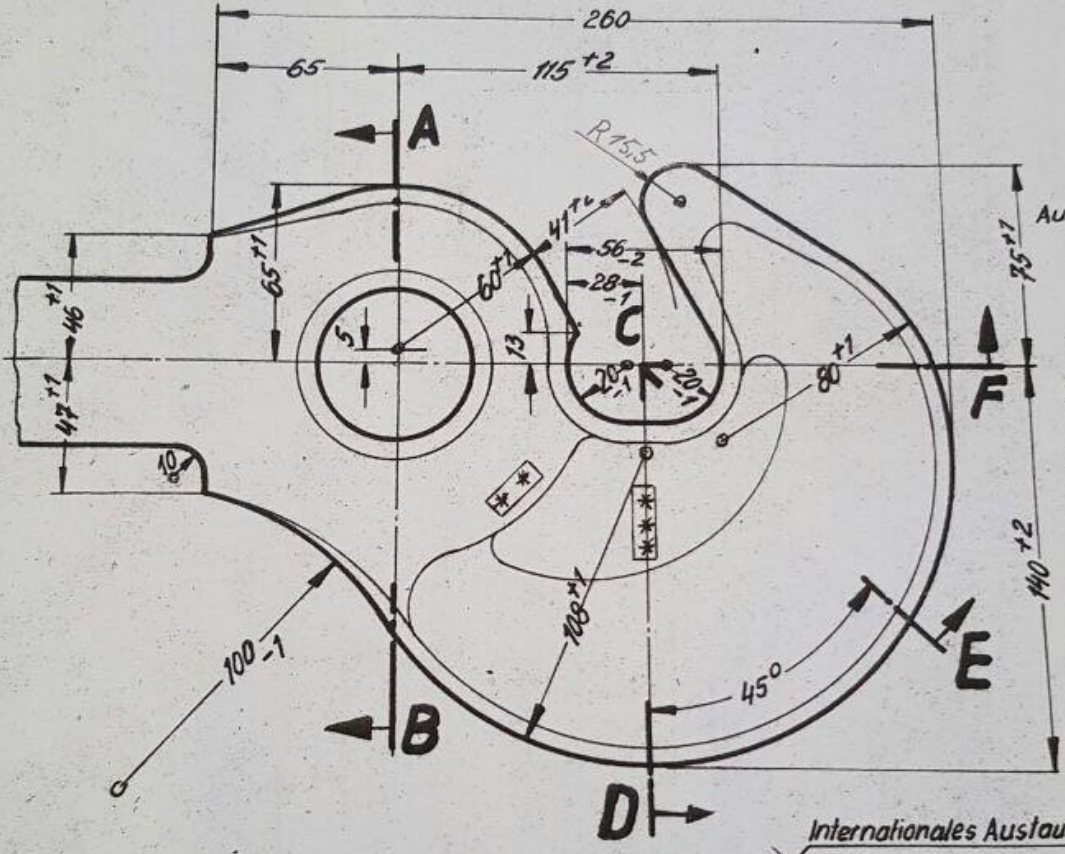

Internationales Austauschbarkeit Maß

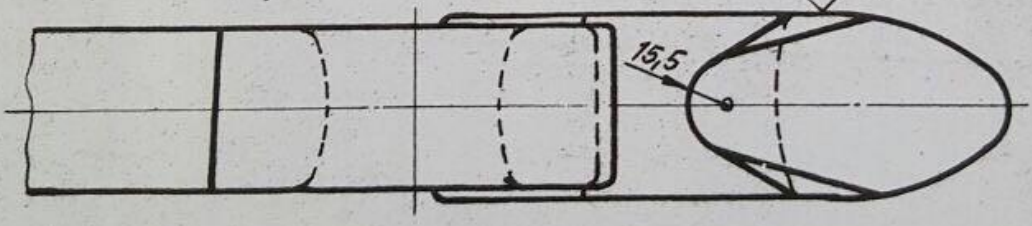
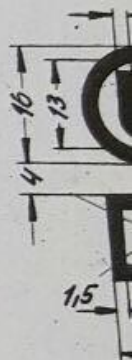

Internationales Austauschbarkeit

Schnitt C-F

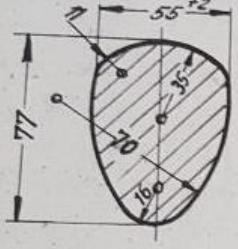

Schnitt C-E

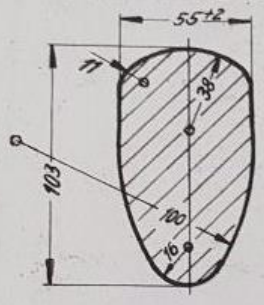

Schnitt C-D

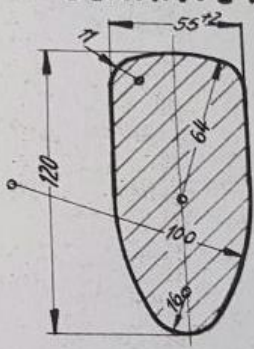

Schnitt A-B

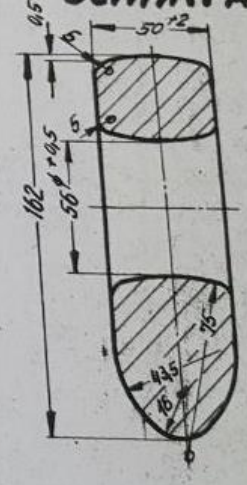

* Bru
Nach

** ke
un

*** A

nac

ellerkennzeichen